

@ECU118

* 1 : Shielded

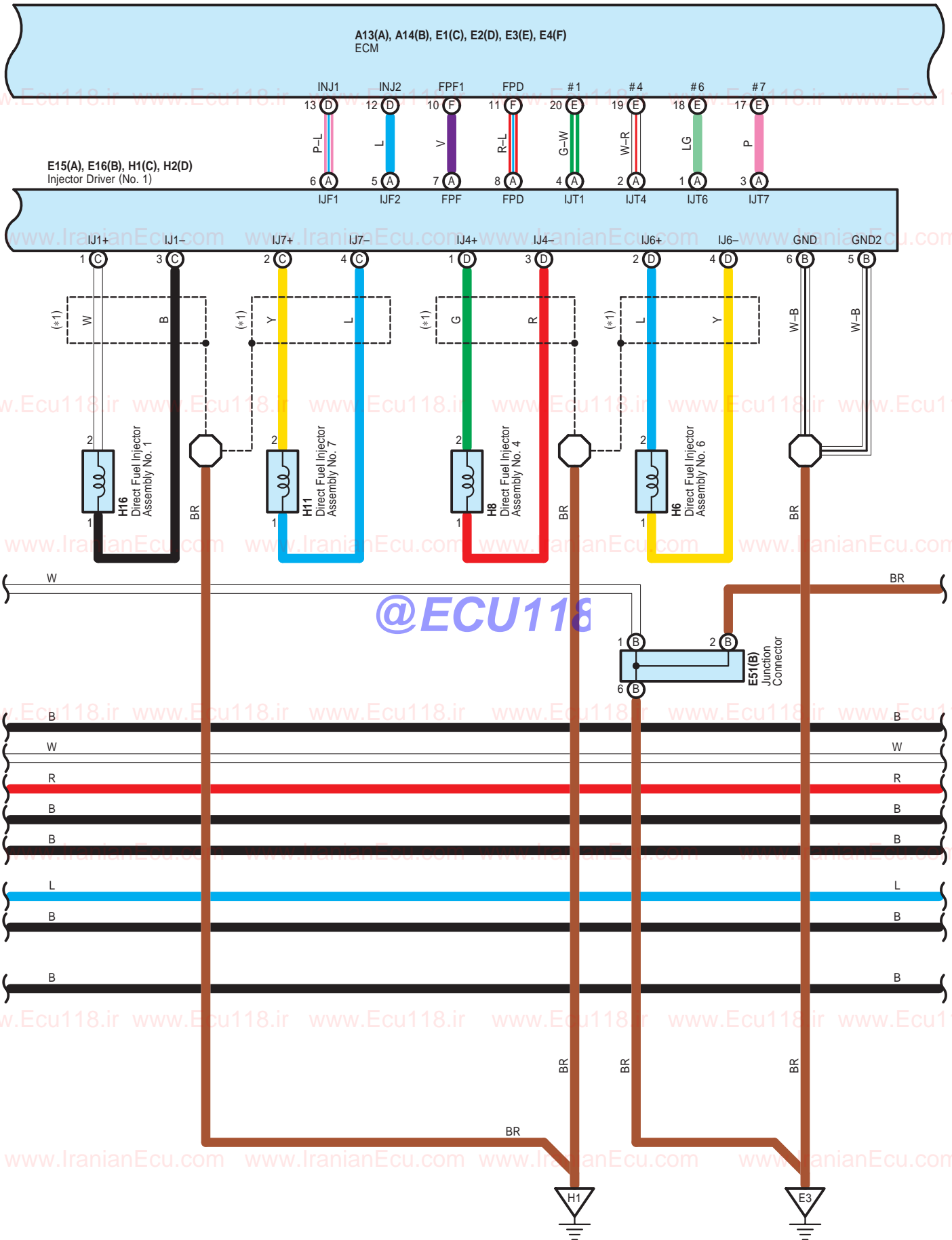

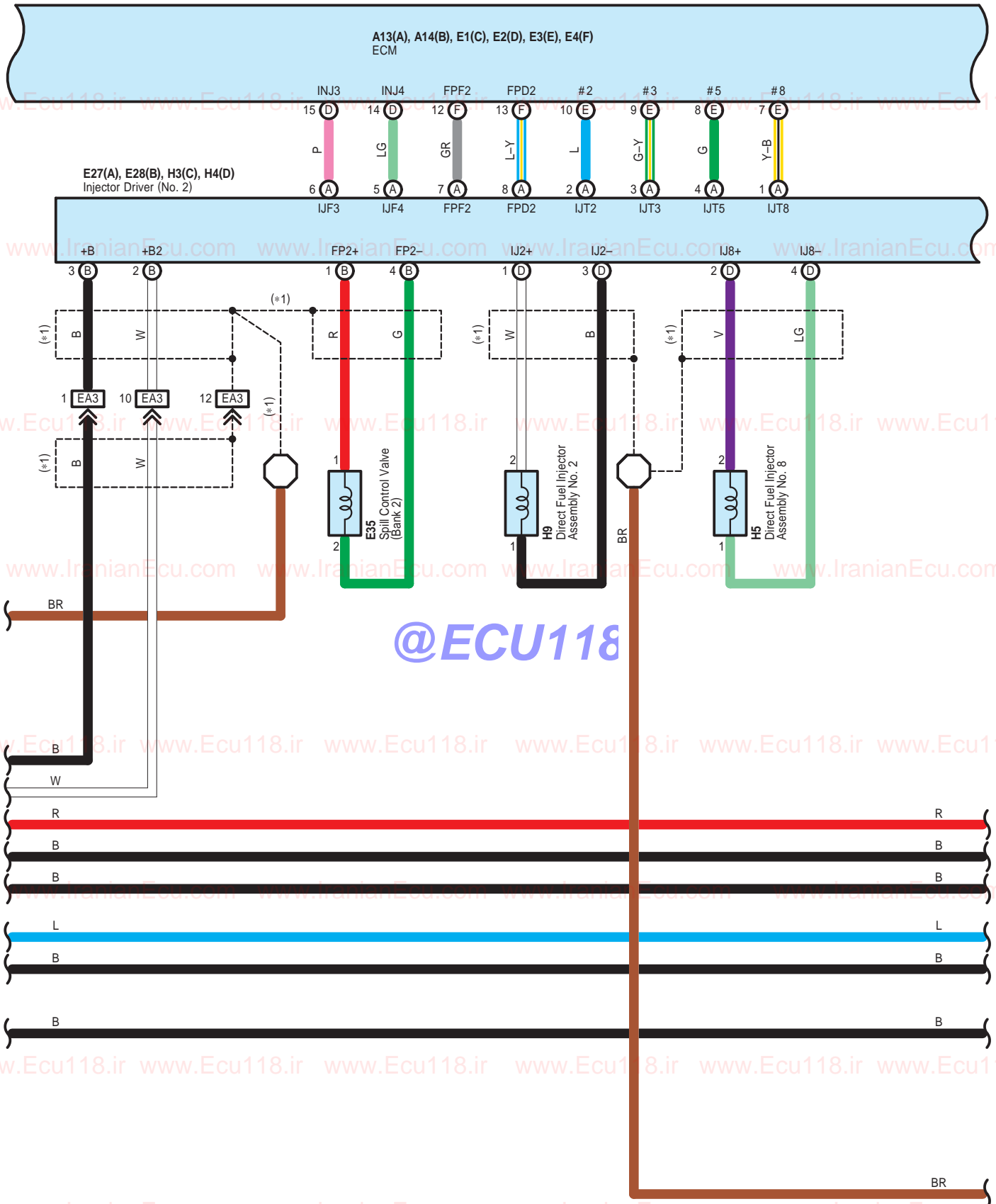

@ECU118

* 1 : Shielded

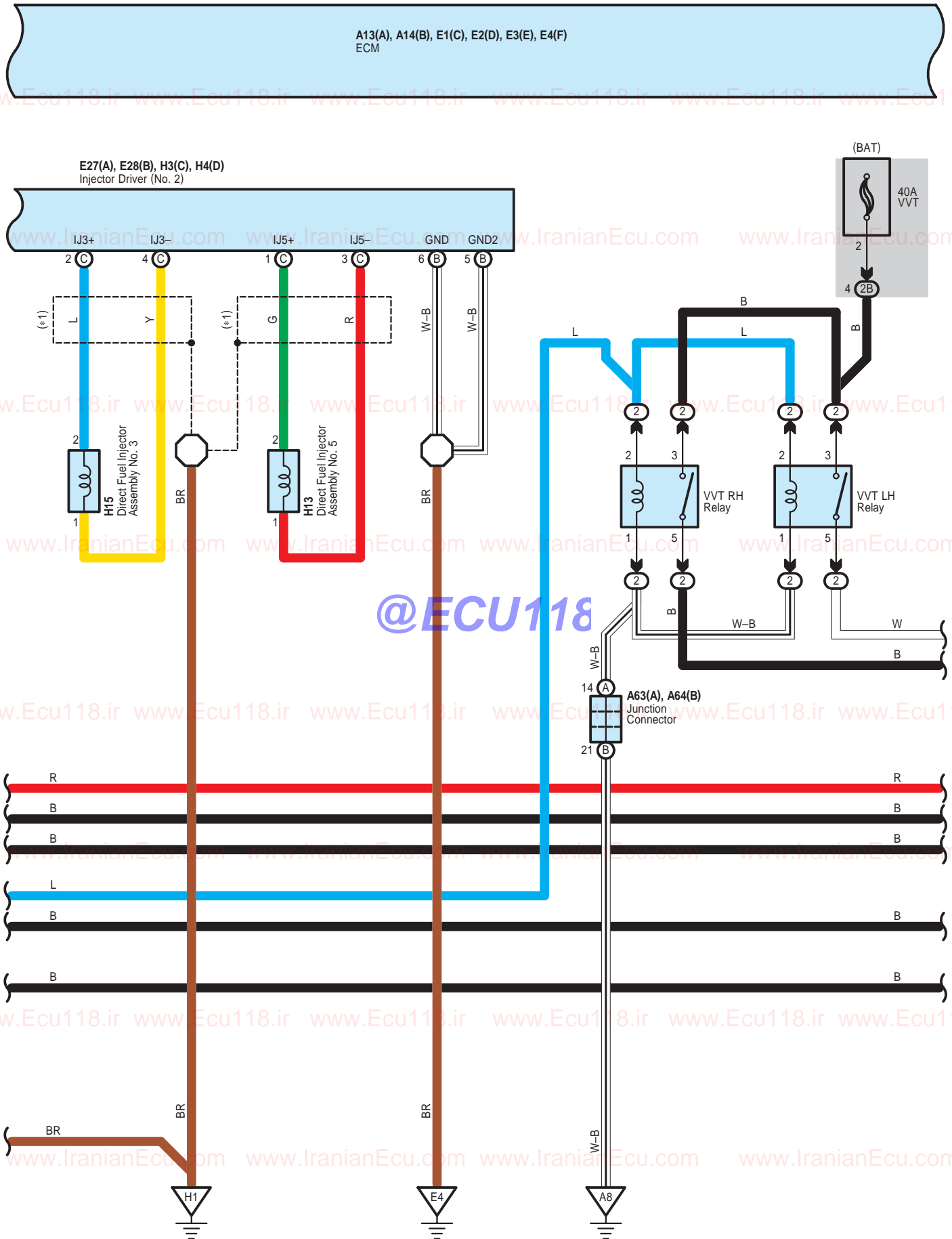

@ECU118

Engine Control

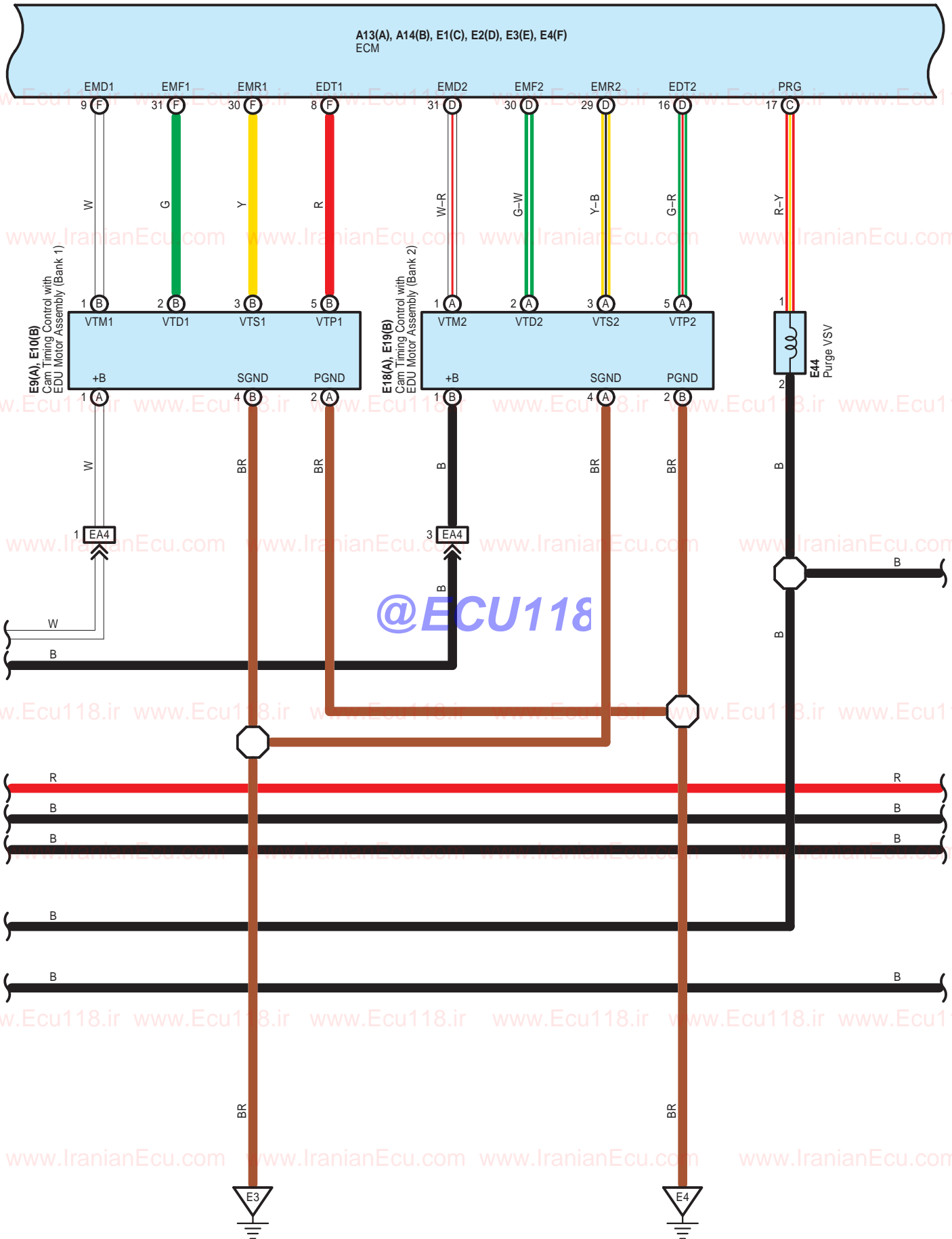

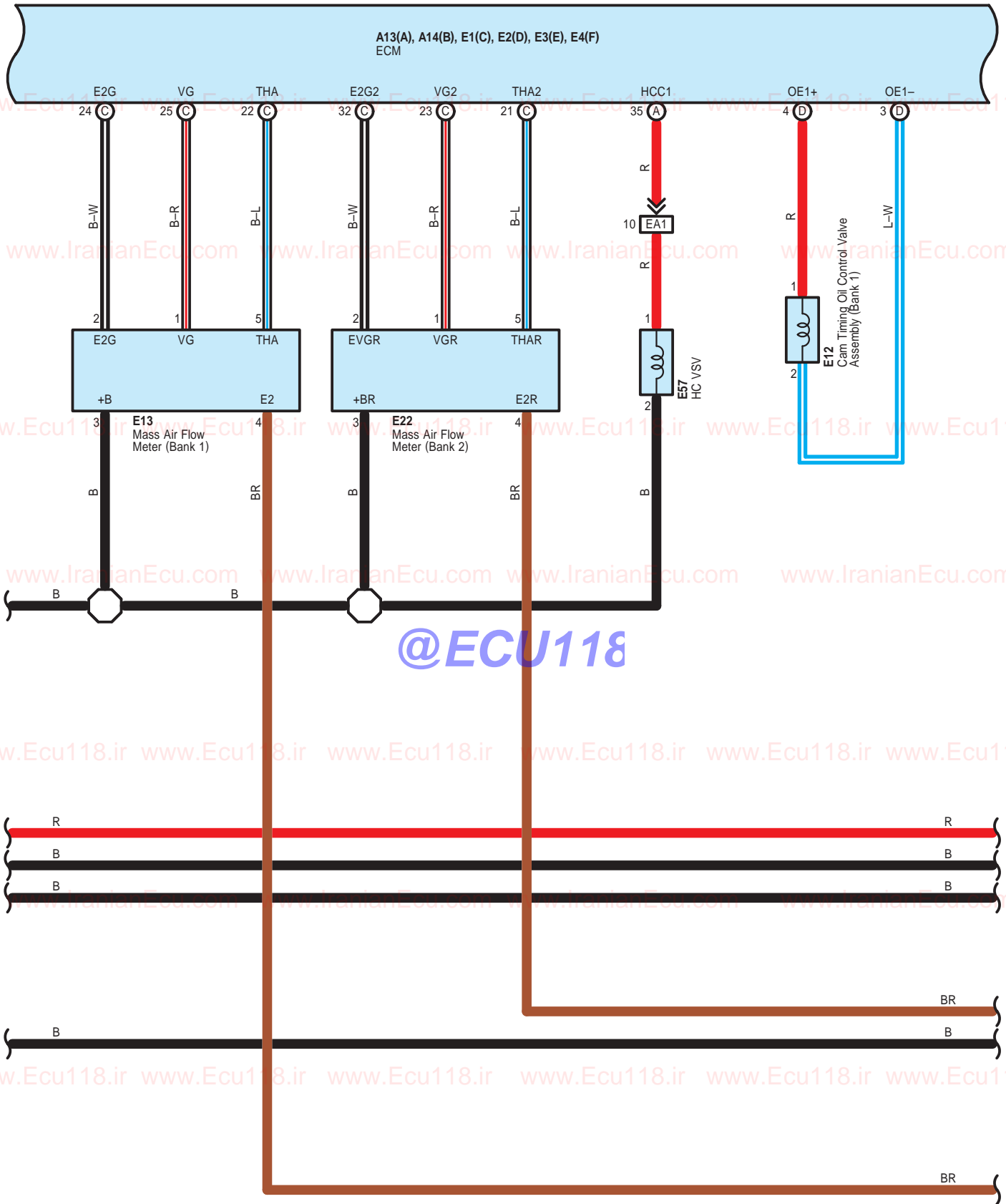

@ECU118

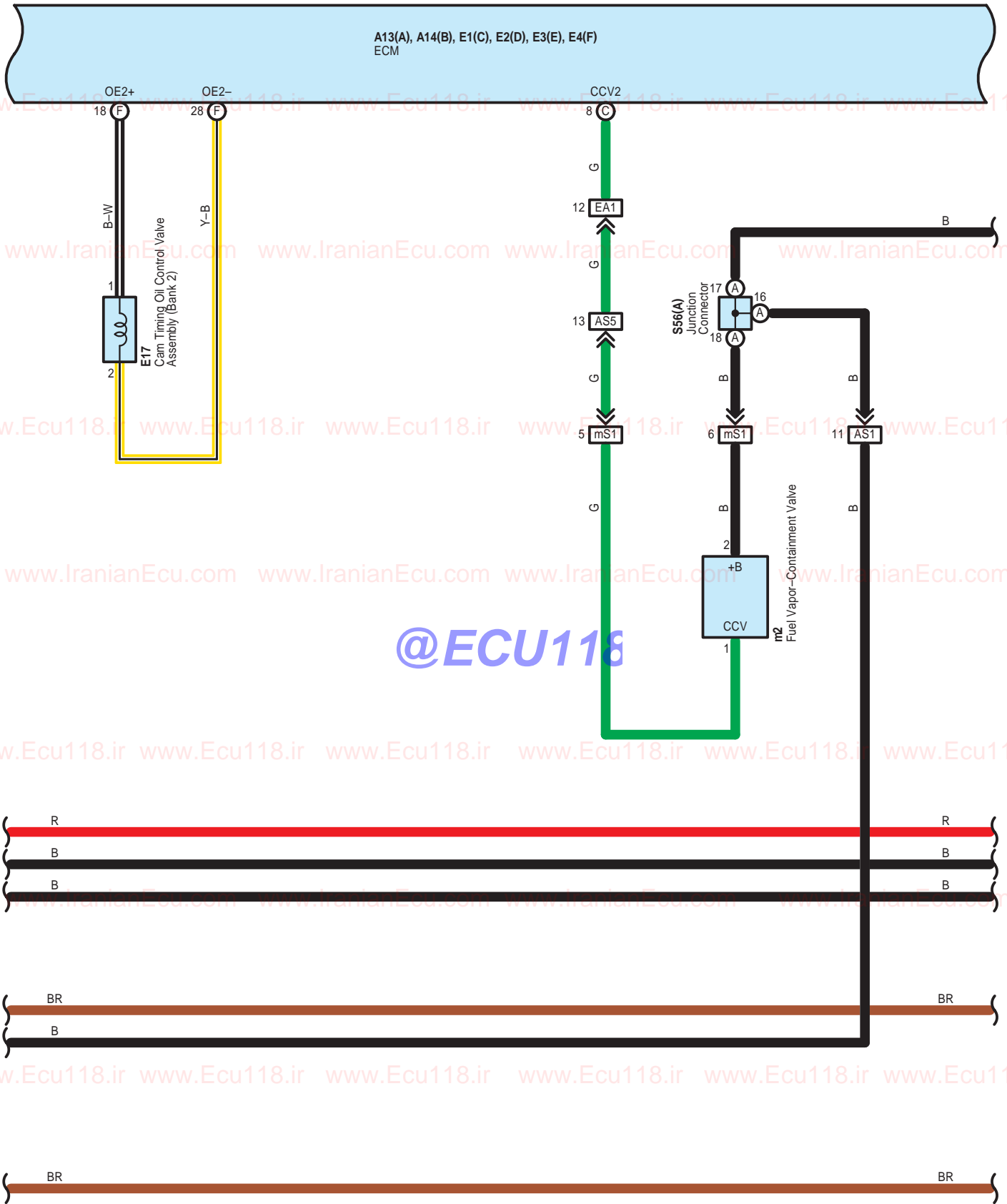

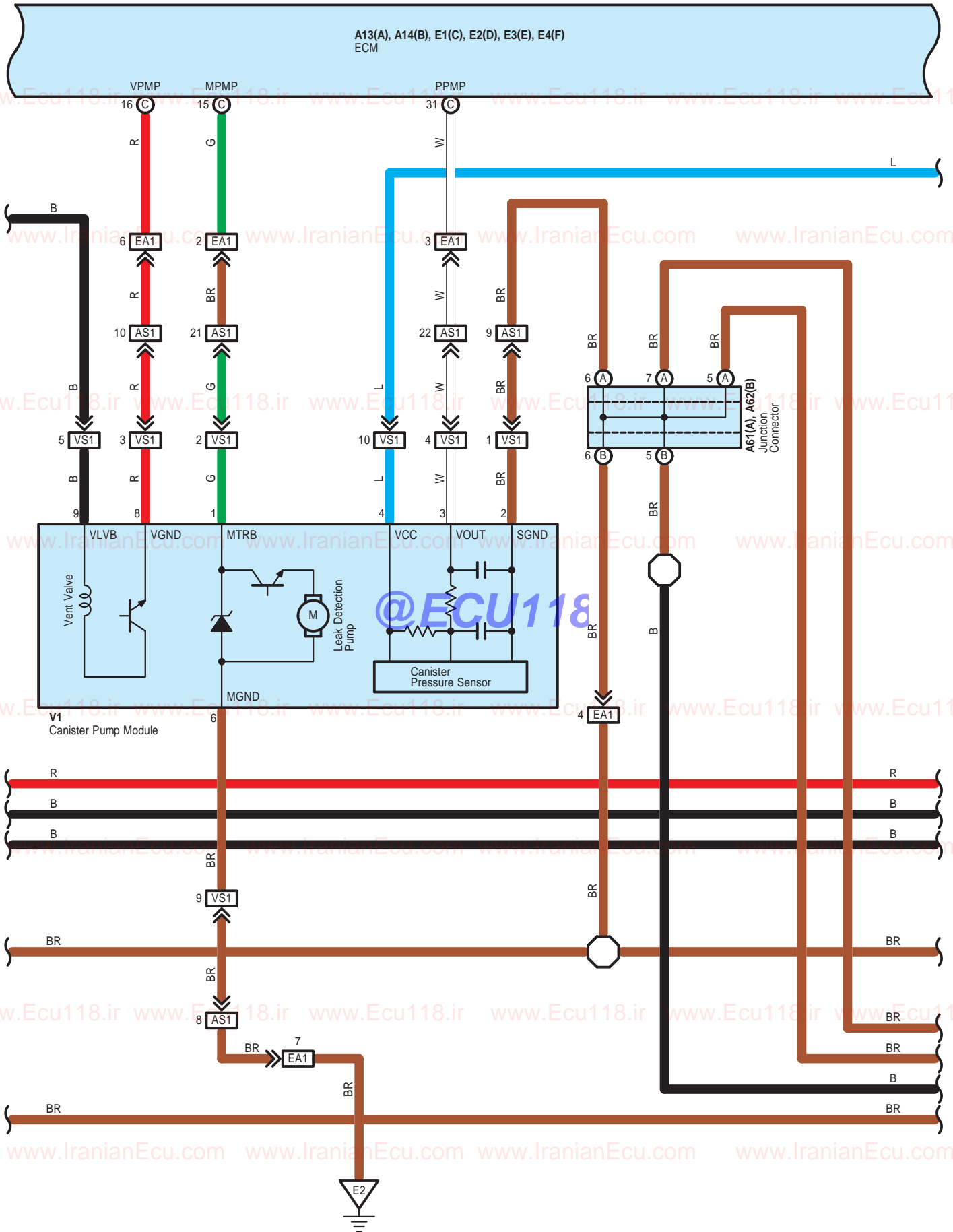

Engine Control

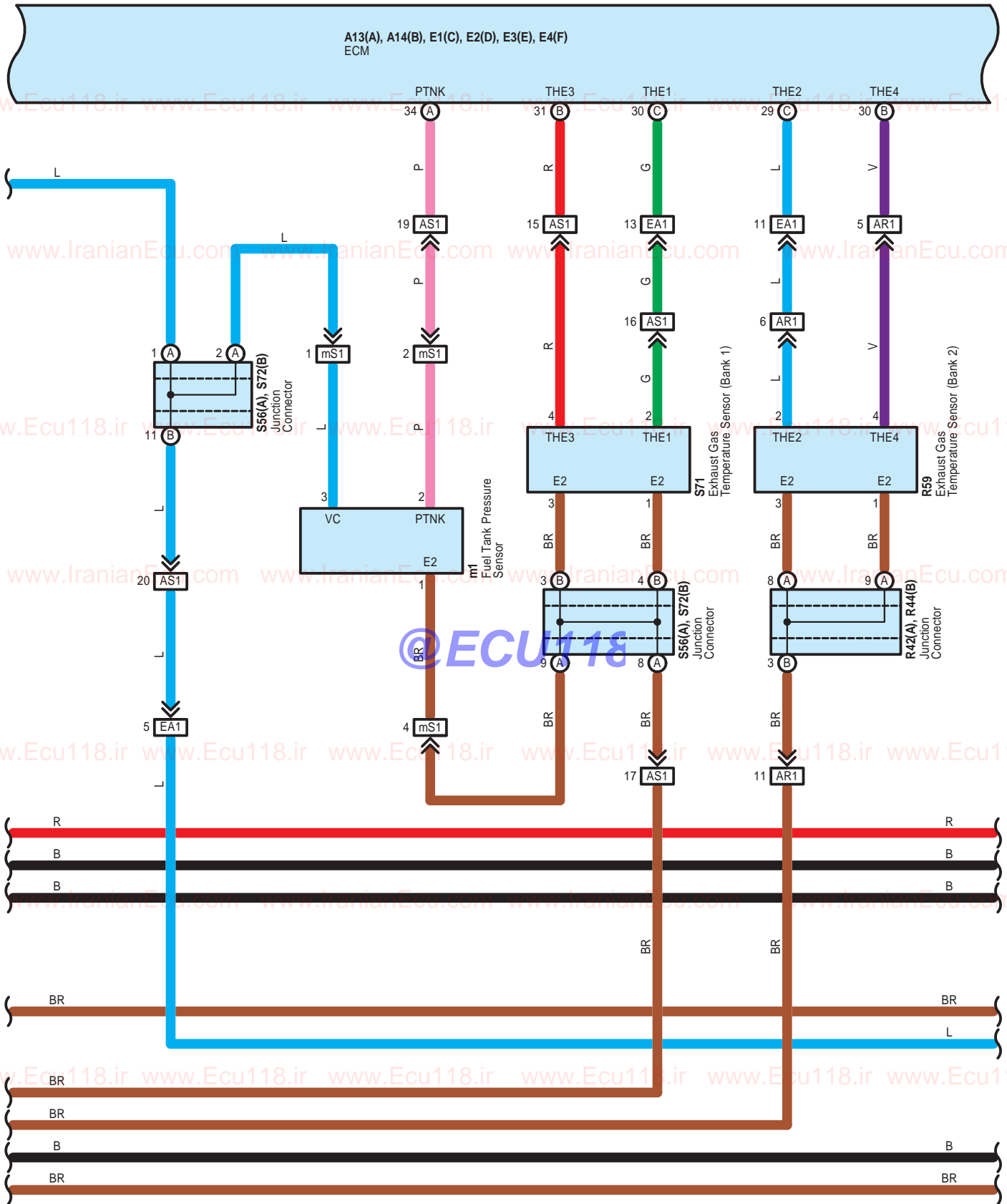

* 1 : Shielded

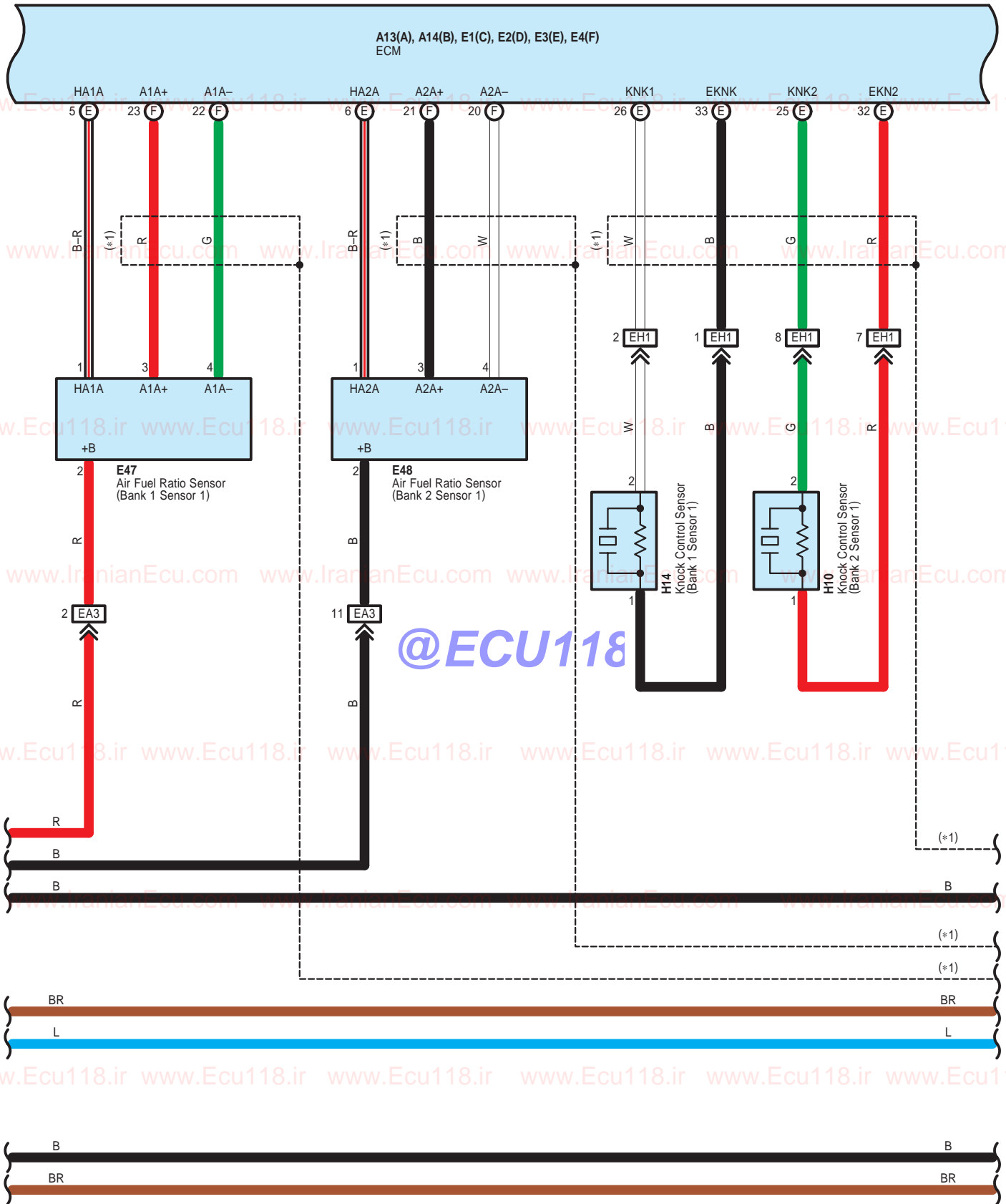

* 1 : Shielded

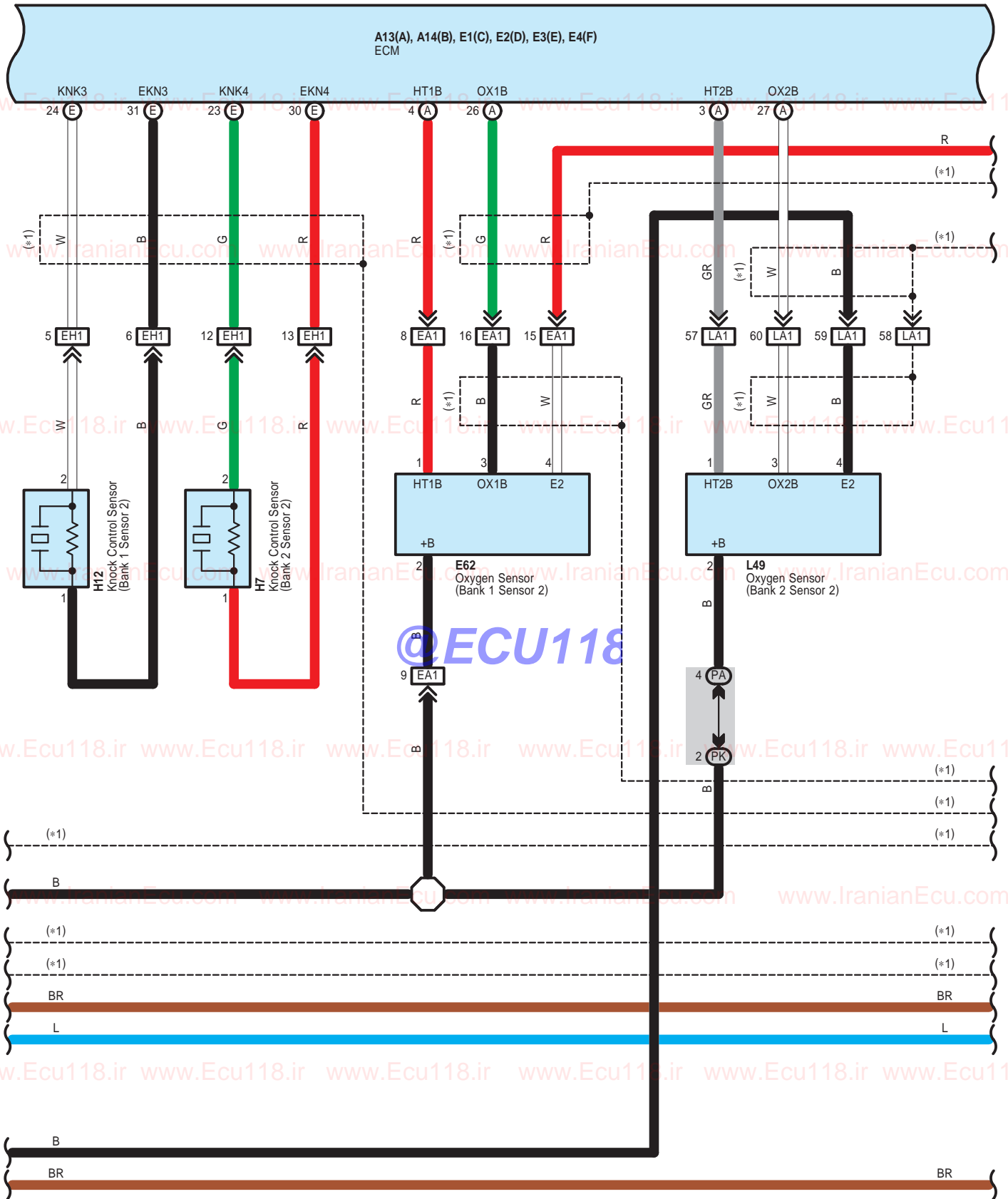

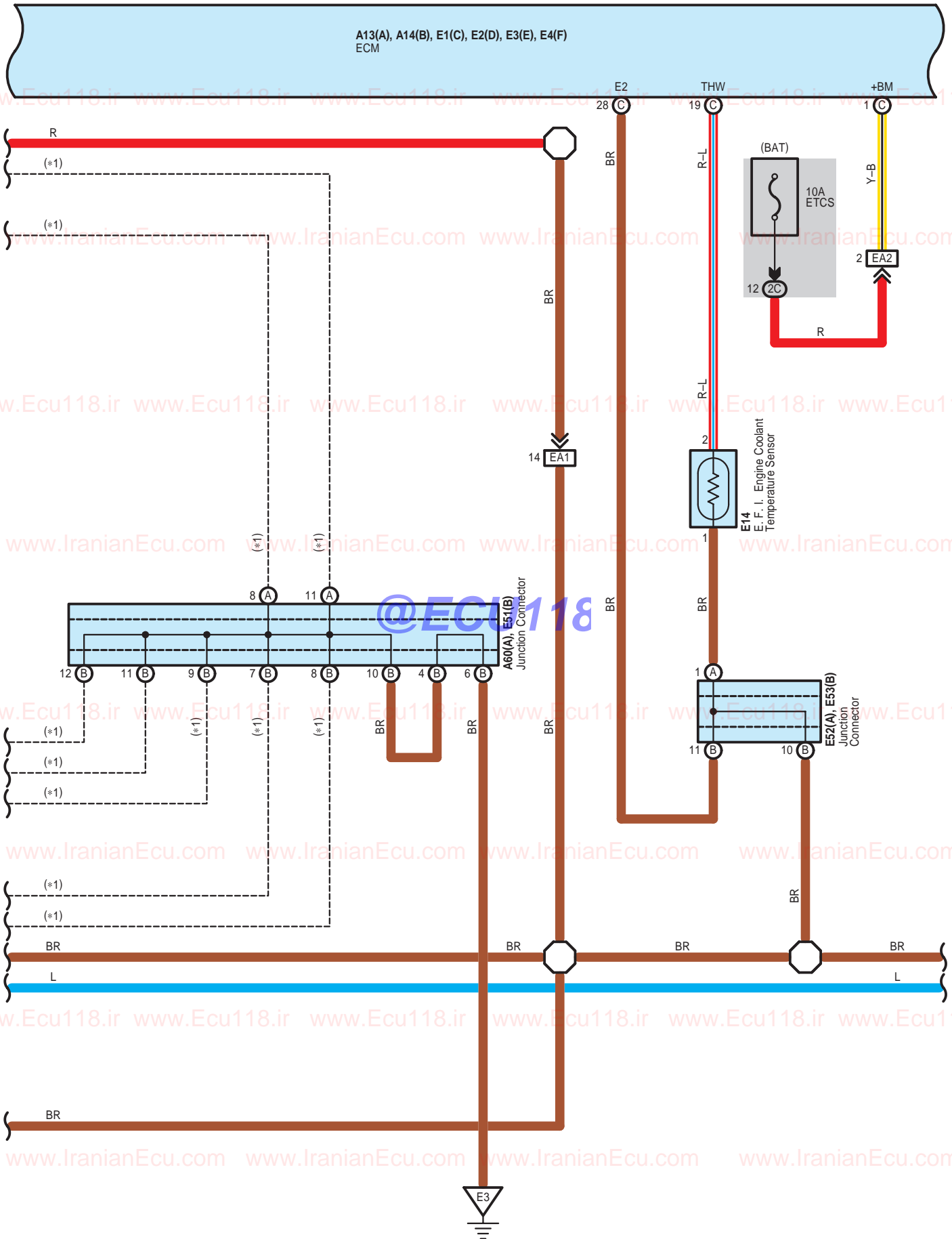

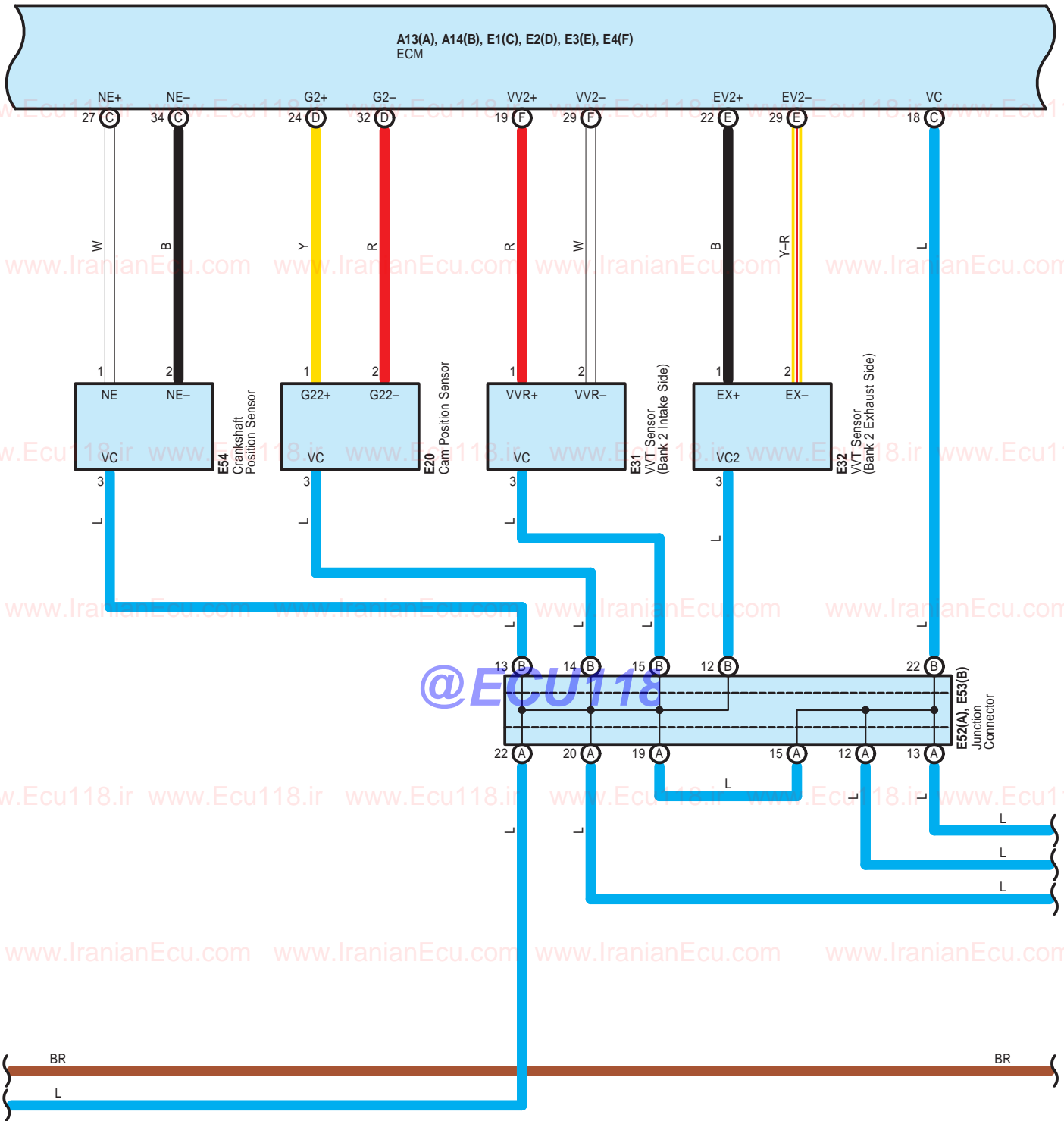

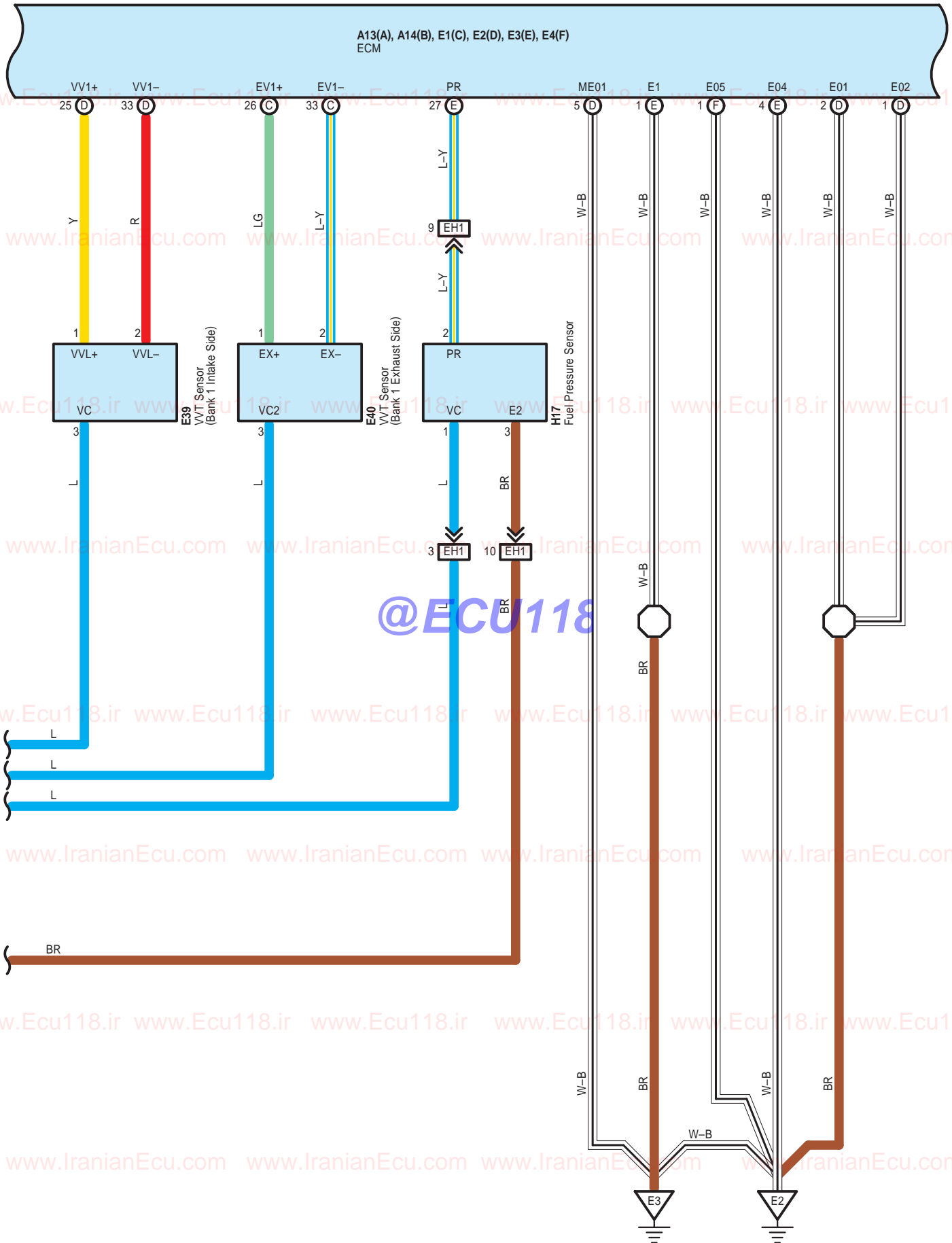

* 1 : Shielded

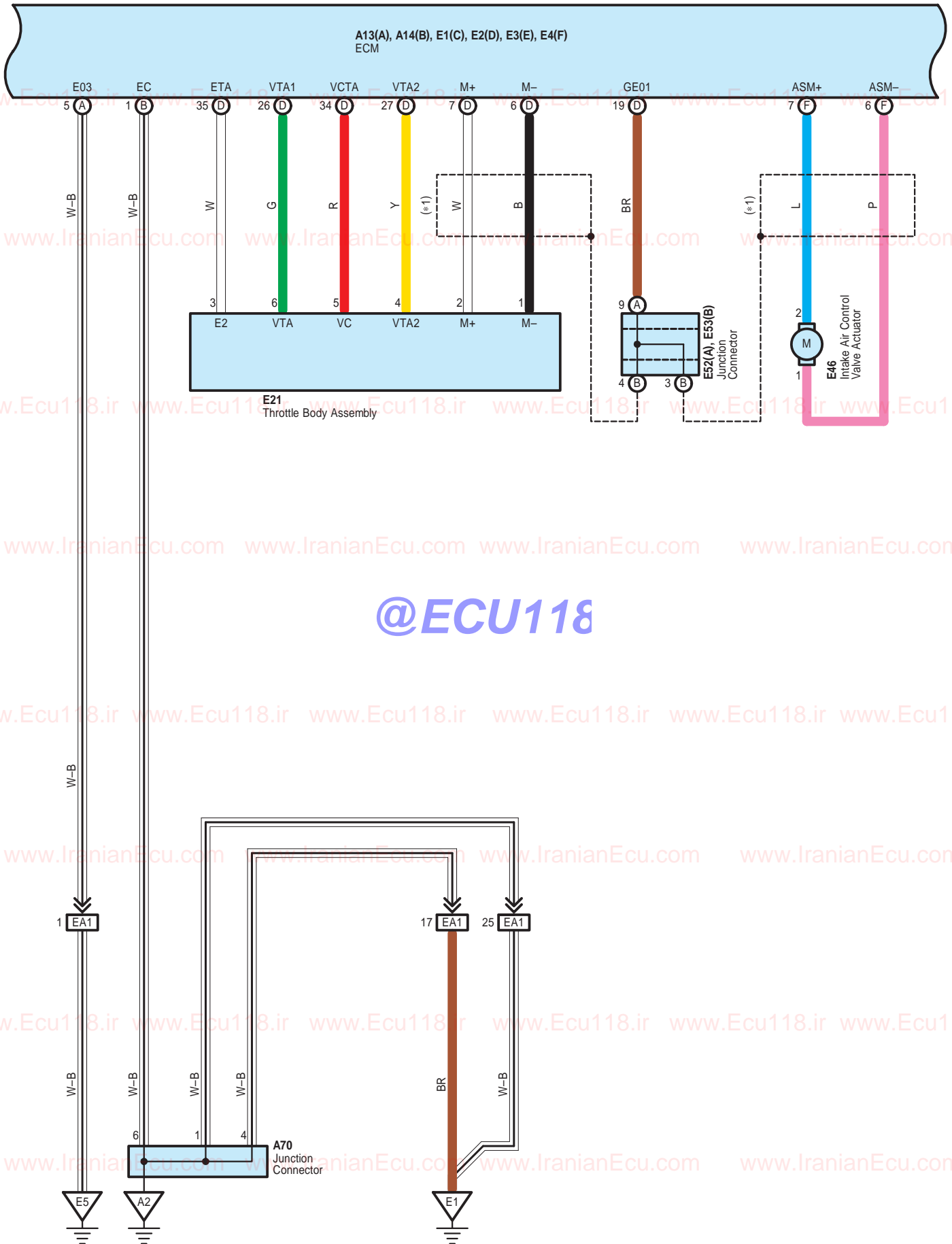

@ECU118

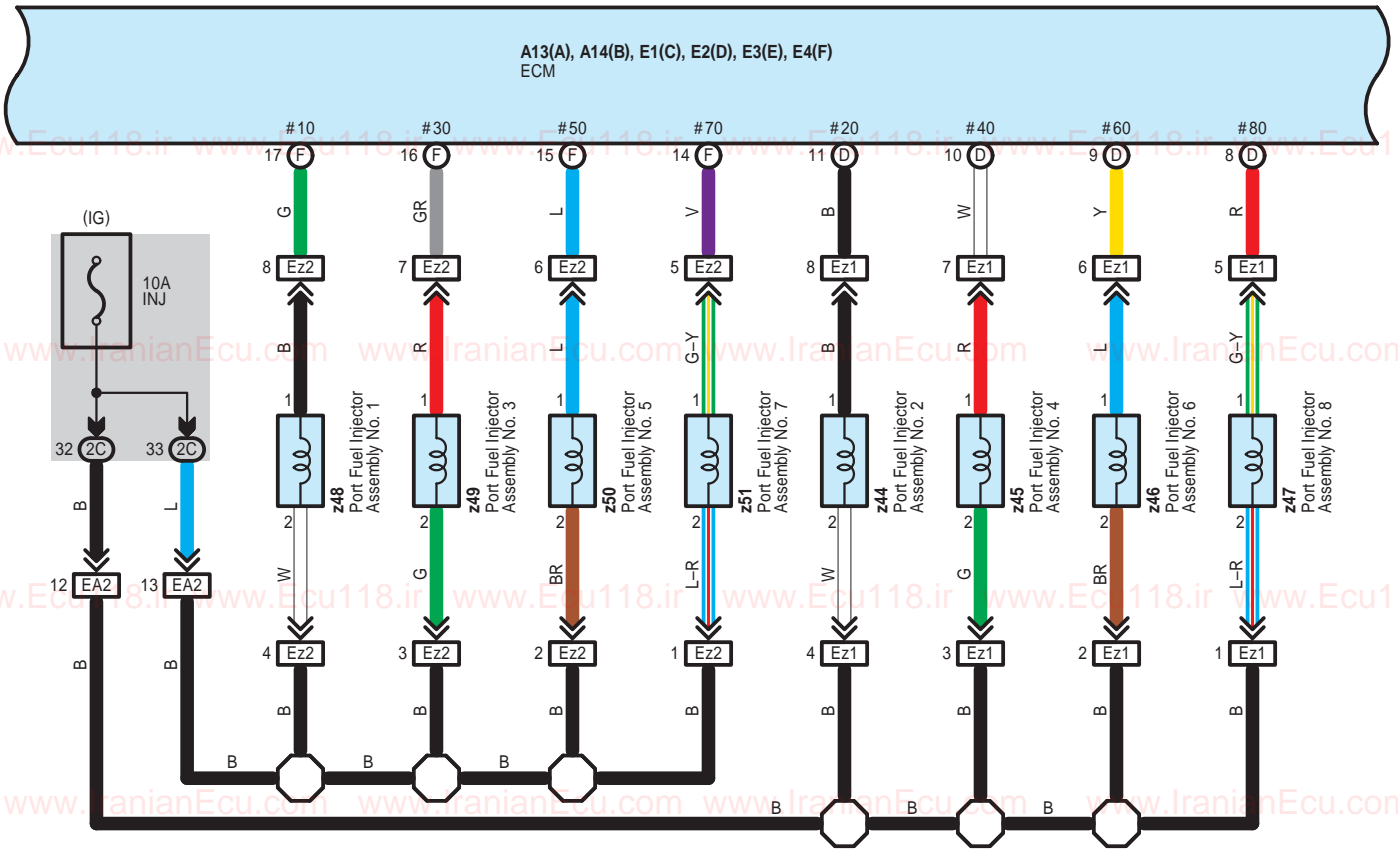

@ECU118

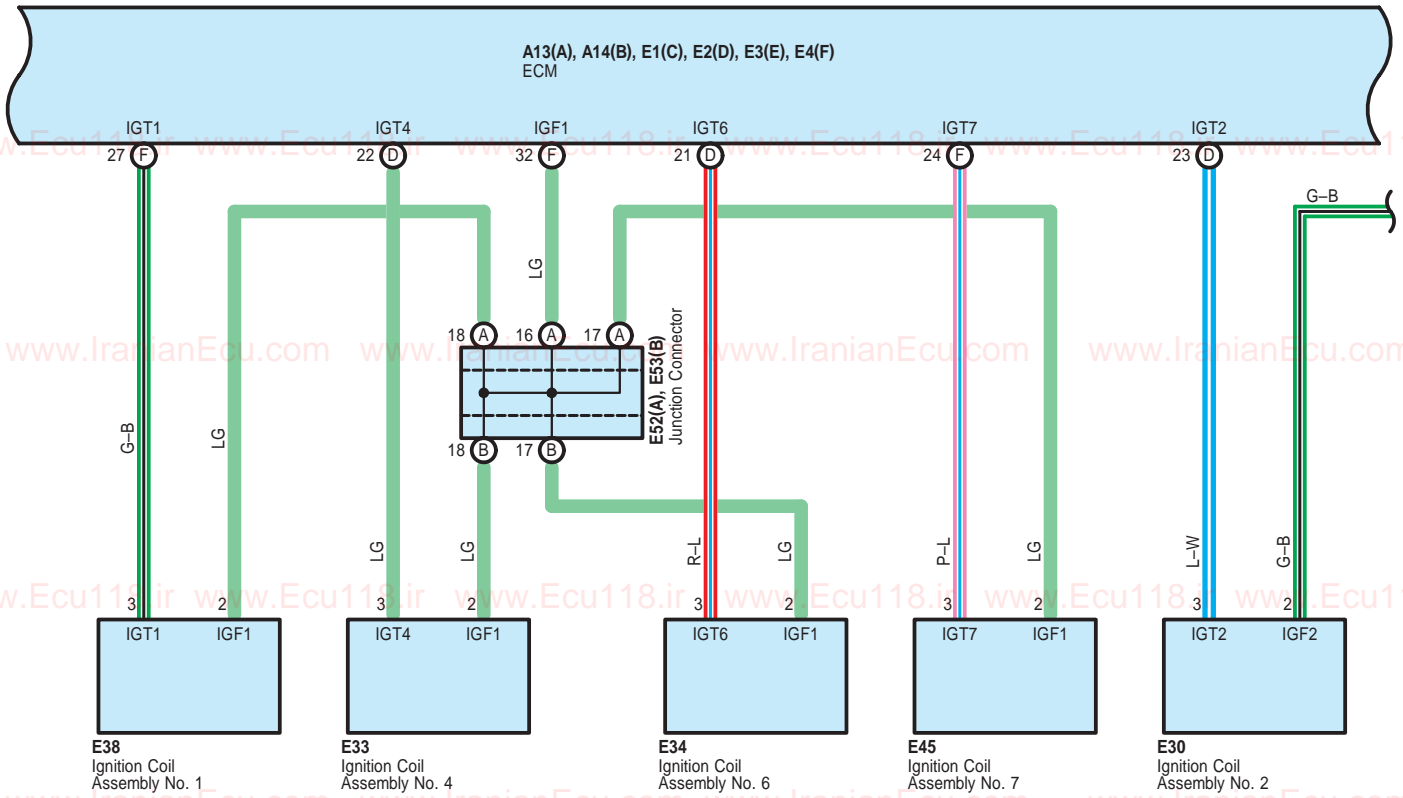

@ECU118

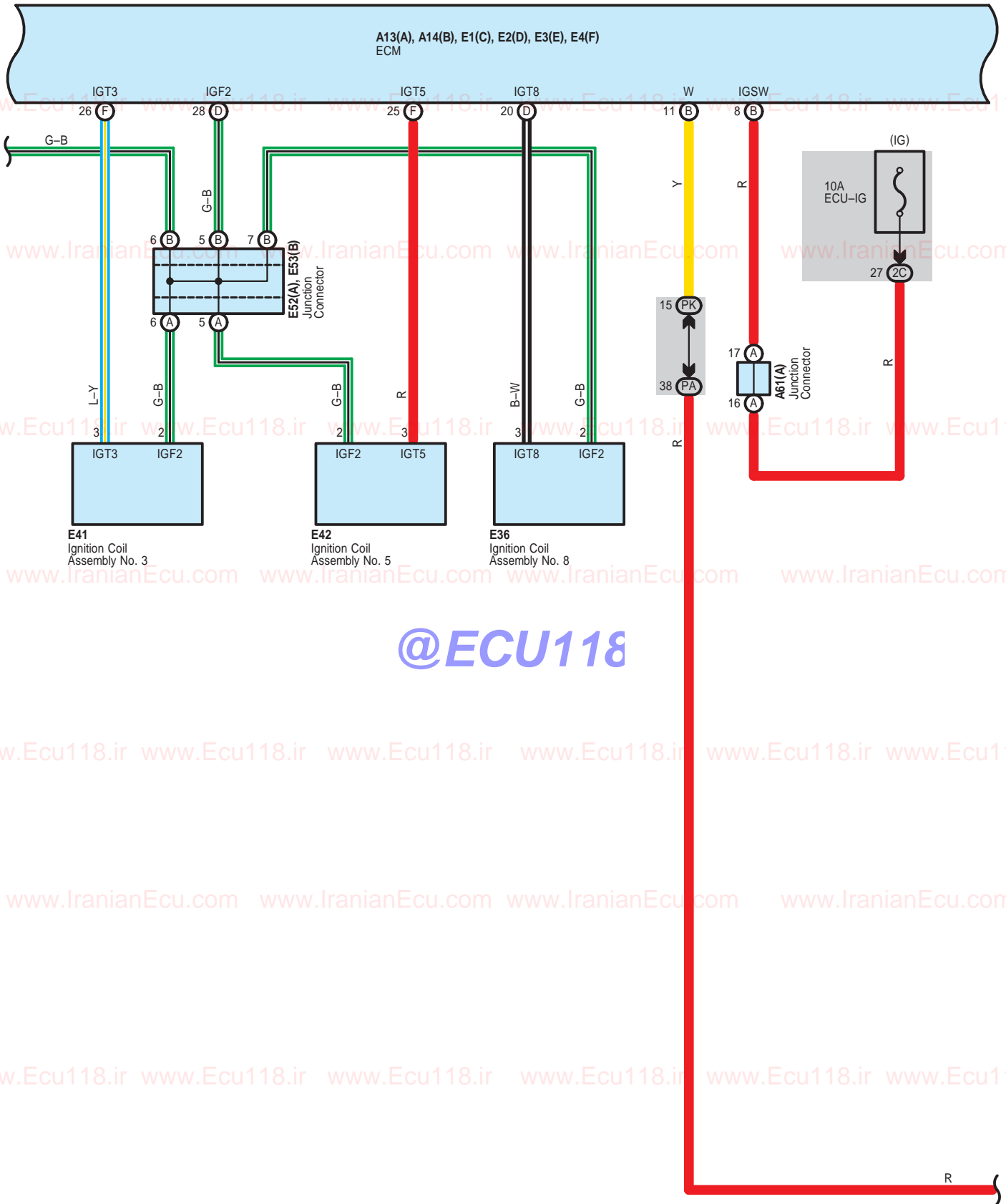

@ECU118

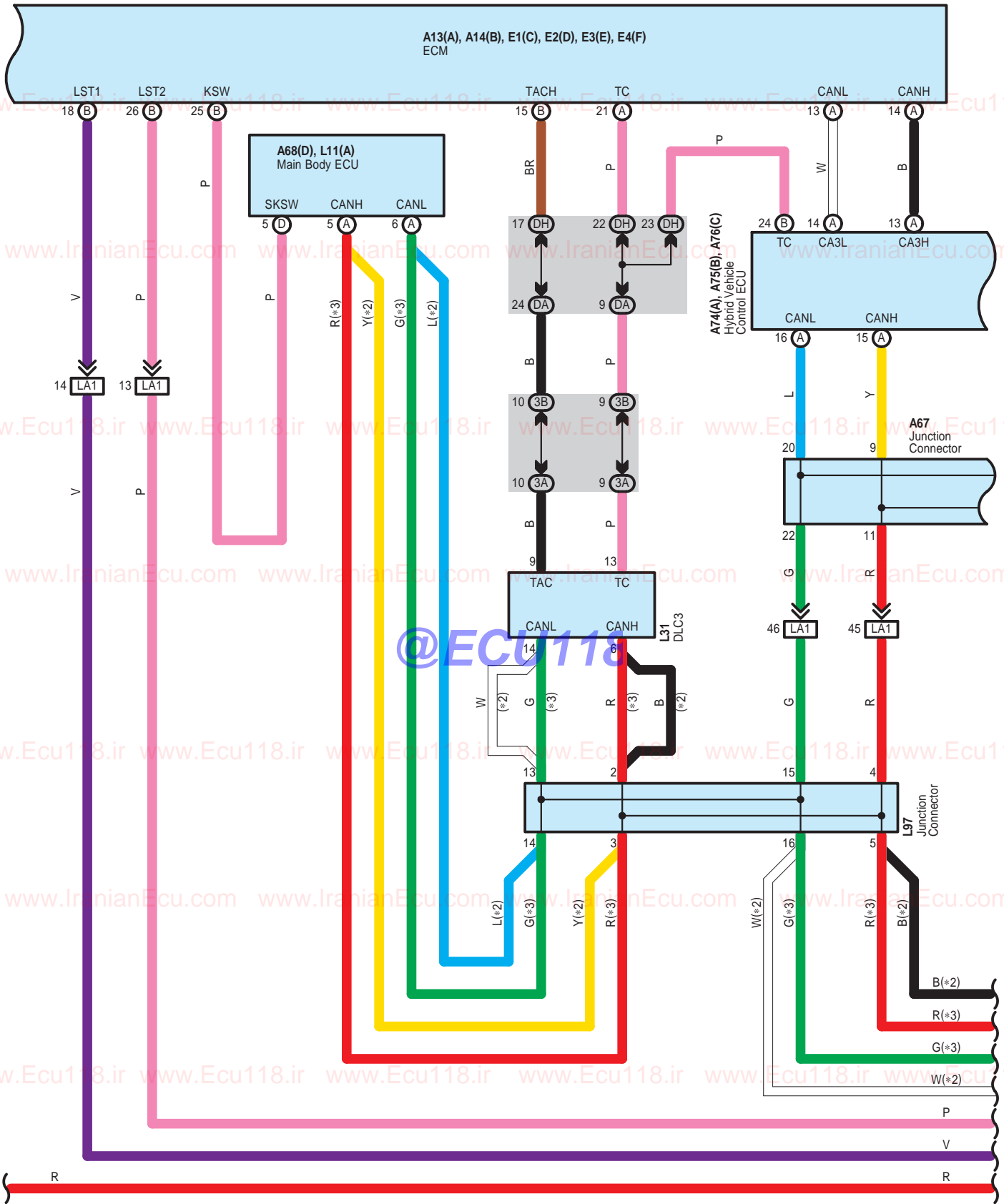

Note :
Please refer to the Multiplex Communication System (CAN) section
for information regarding the shielded communication lines.

- * 1 : Shielded
- * 2 : Before May 2010 Production
- * 3 : From May 2010 Production

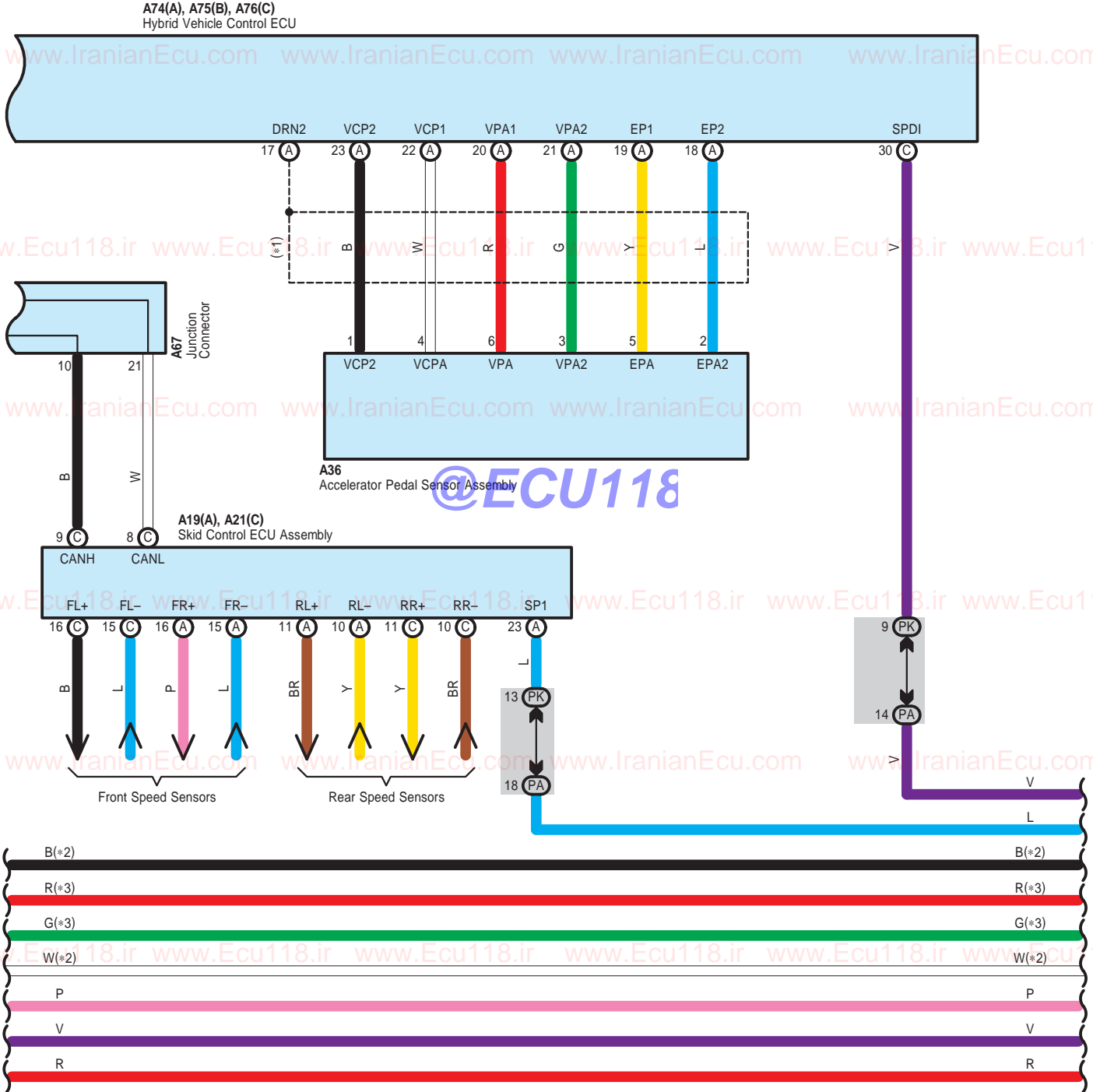

Note :
Please refer to the Multiplex Communication System (CAN) section
for information regarding the shielded communication lines.

- * 2 : Before May 2010 Production
- * 3 : From May 2010 Production

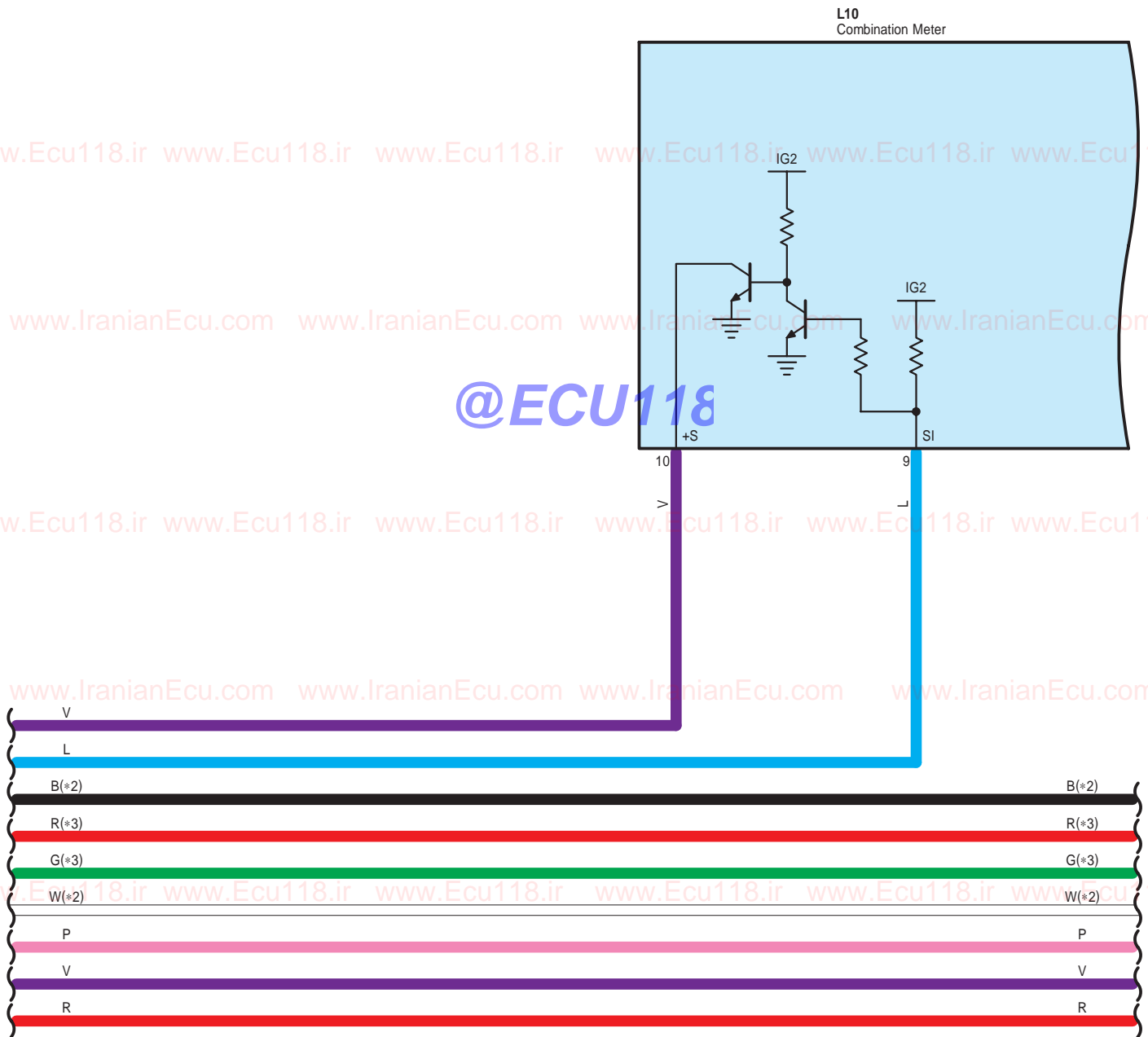

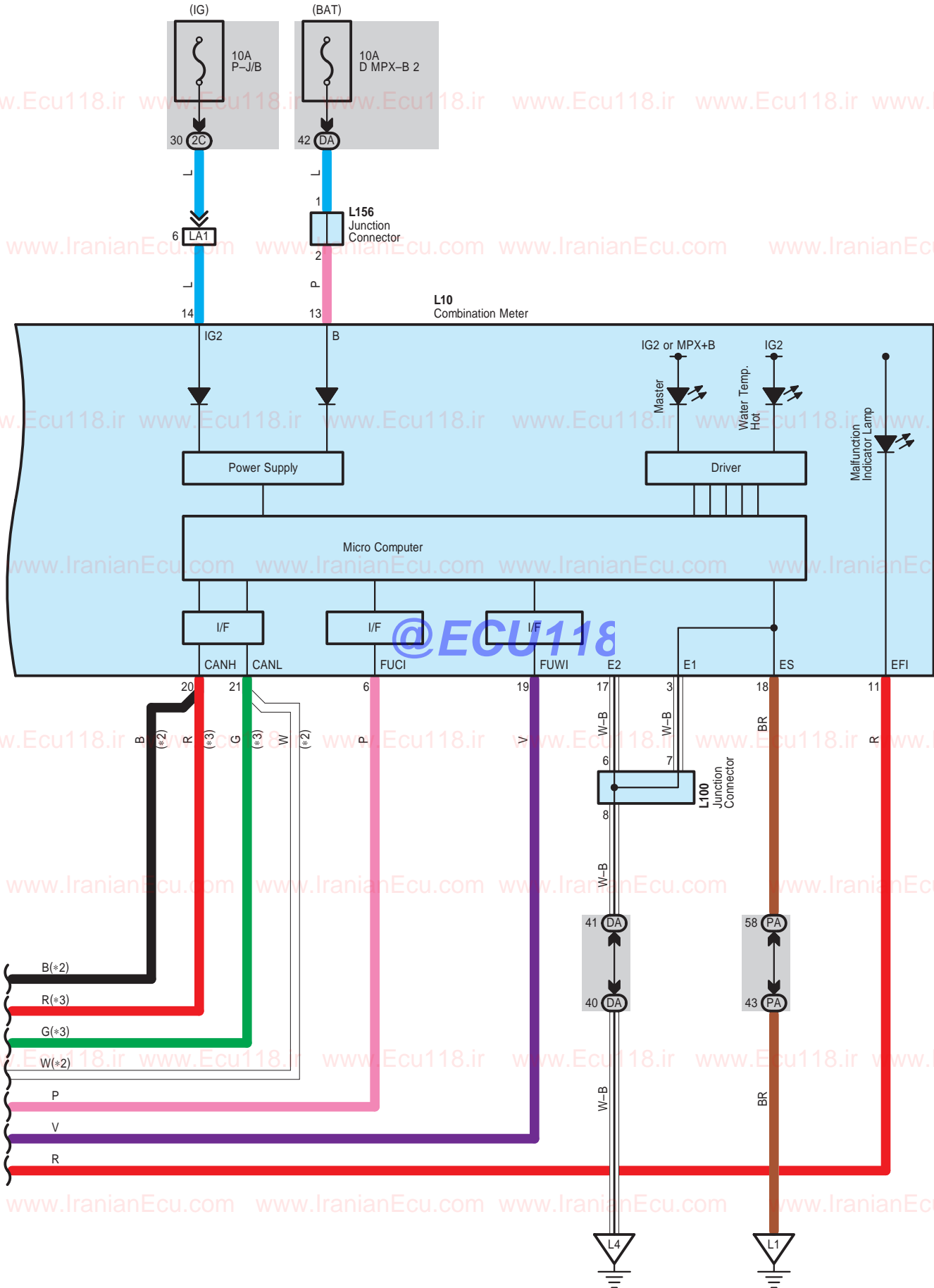

Engine Control

A 13
White

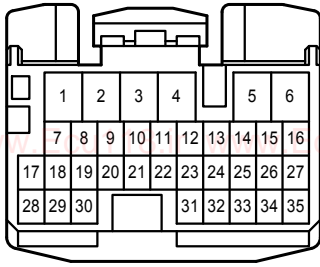

A 14
White

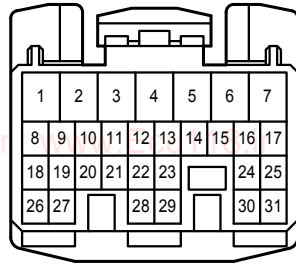

A 16
Black



A 19
Black

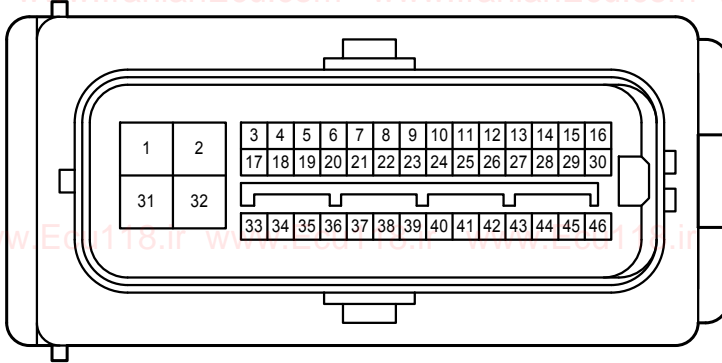

A 21
Gray

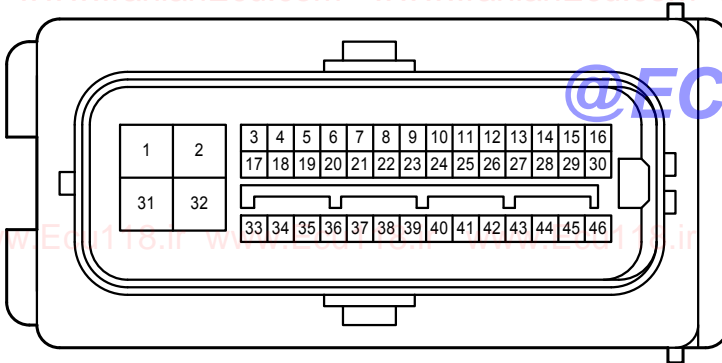

A 36
Black

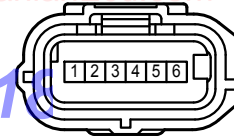

A 60
Blue

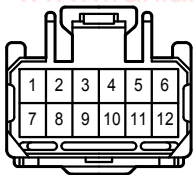

A 61
Black

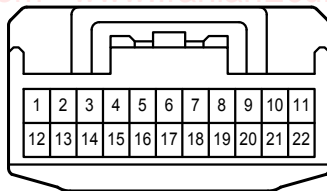

A 62
Blue

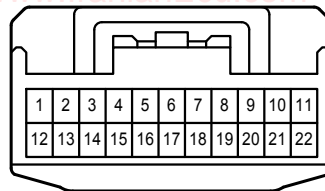

A 63
Black

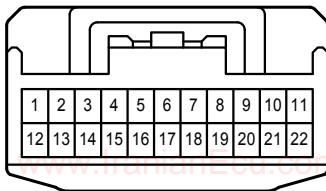

A 64
Black

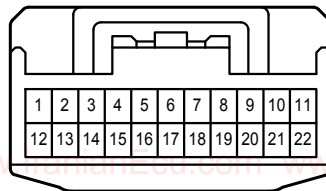

A 67
Black

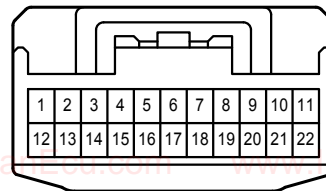

Engine Control

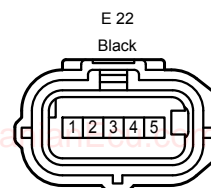
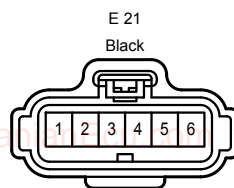
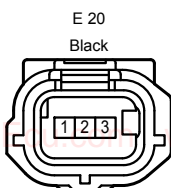
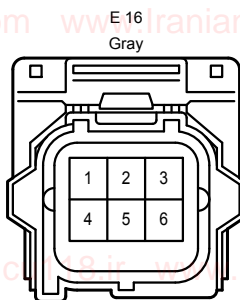
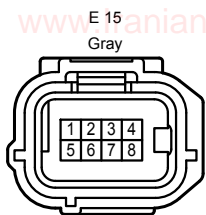
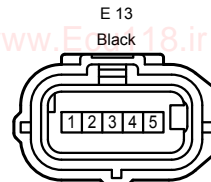
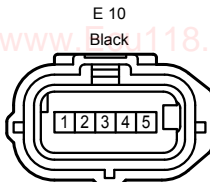
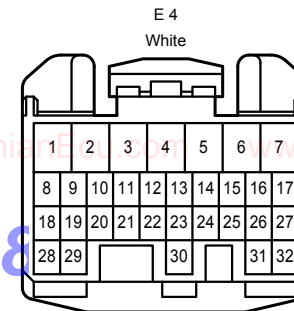
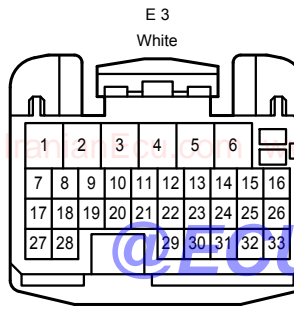
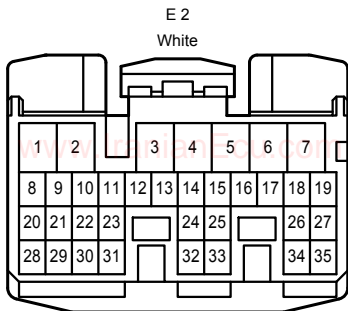
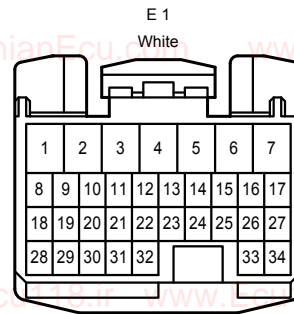
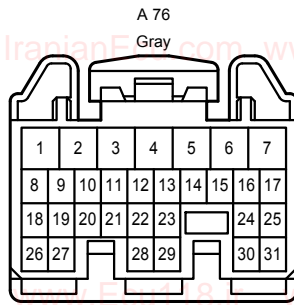
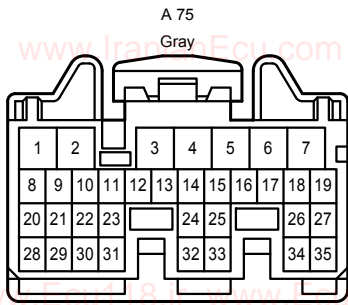
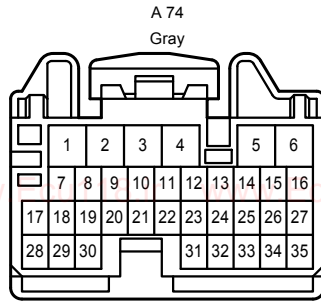
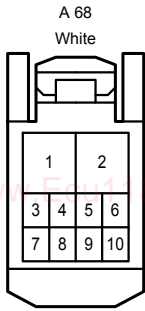

Engine Control

E 27
Gray

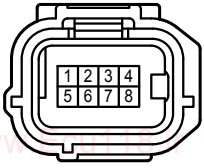

E 28
Gray

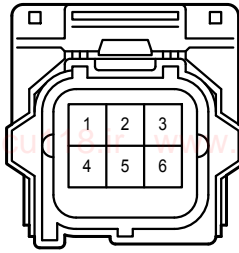

E 30
Gray

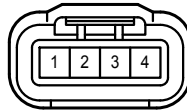

E 31
Black

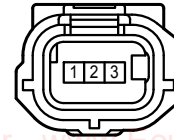

E 32
Black

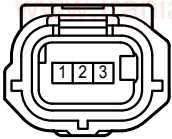

E 33
Black

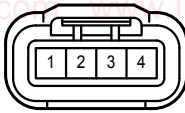

E 34
Gray

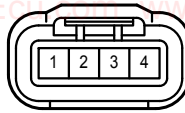

E 35
Gray

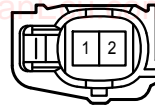

E 36
Black

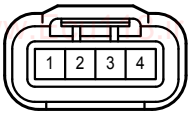

E 38
Gray

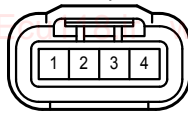

E 39
Black

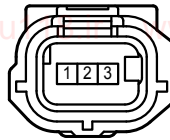

E 40
Black

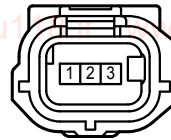

E 41
Black

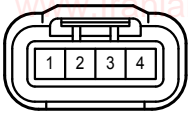

E 42
Gray

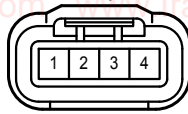

E 43
Gray

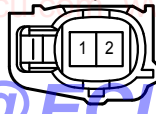

E 44
Black

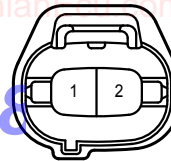

E 45
Black

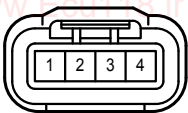

E 46
Black

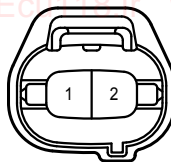

E 47
Dark Gray



E 48
Dark Gray



E 51
Blue

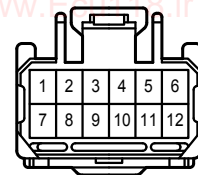

E 52
Black

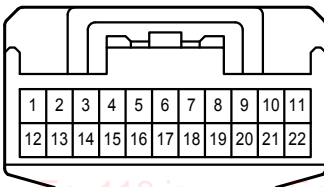

E 53
Black

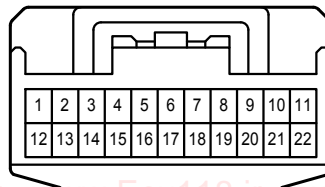

E 54
Black

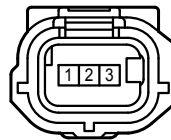

Engine Control

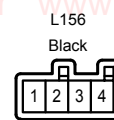
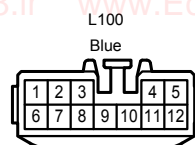
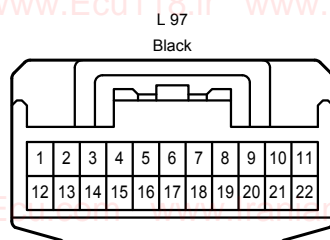
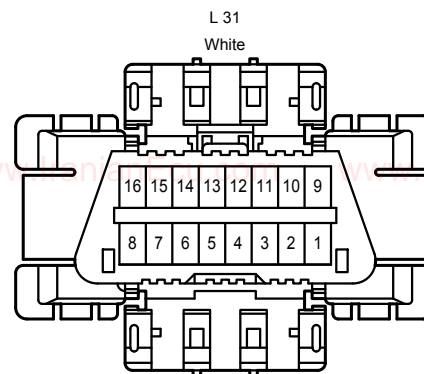
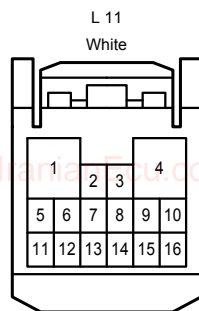
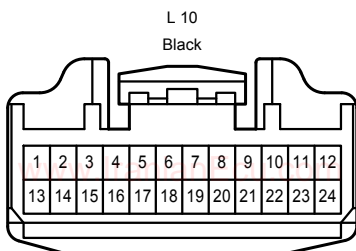
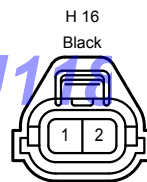
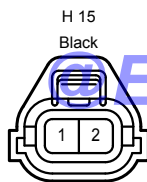
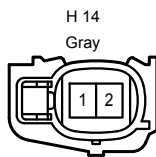
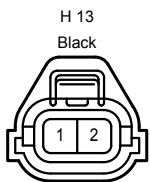
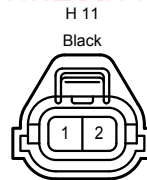
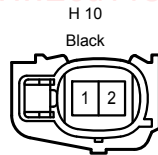
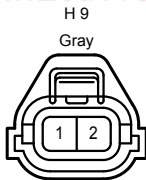
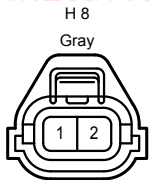
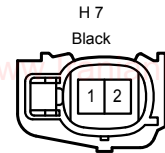
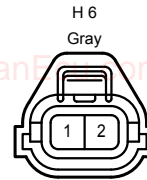
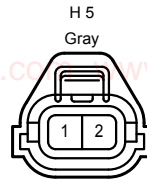
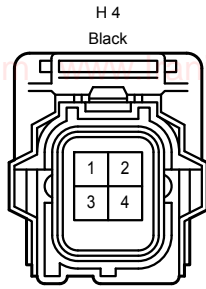
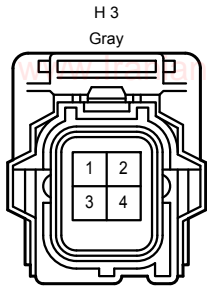
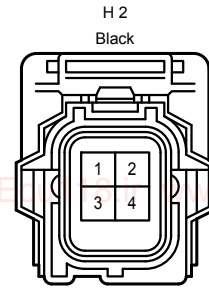
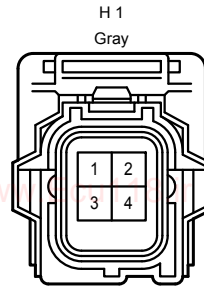
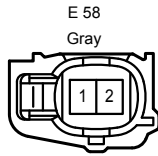
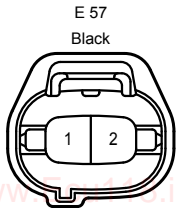

Engine Control

R 42
Black

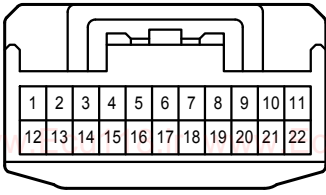

R 44
Black

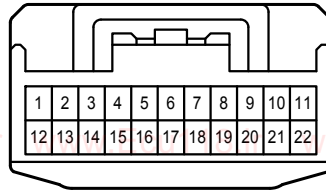

R 59
Dark Gray



S 11
White

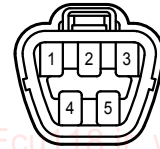

S 56
White

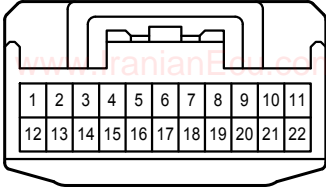

S 57
White

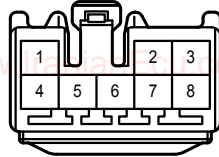

S 71
Dark Gray

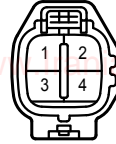

S 72
White

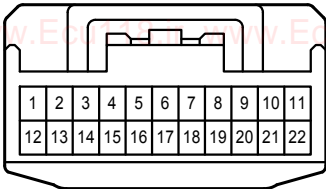

V 1
Black

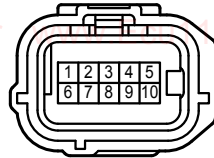

m 1
Black

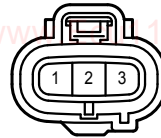

m 2
Black

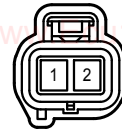

z 44
Black



z 45
Black



z 46
Black

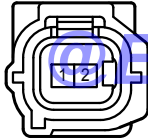

z 47
Black

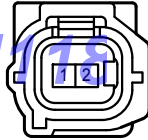

z 48
Black

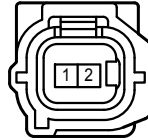

z 49
Black



z 50
Black



z 51
Black



1H



2B
Black

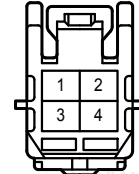

2C
White

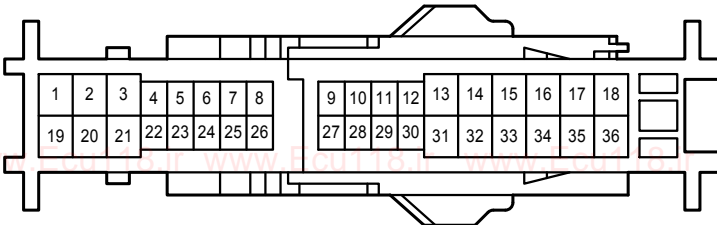

2D
Black

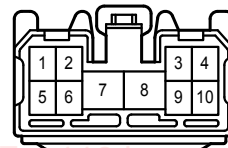

Engine Control

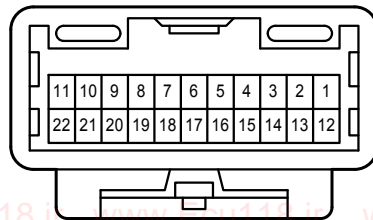
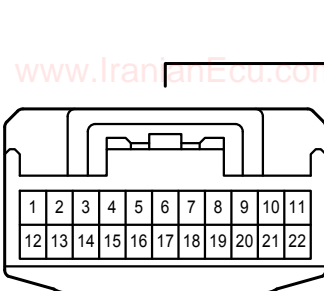
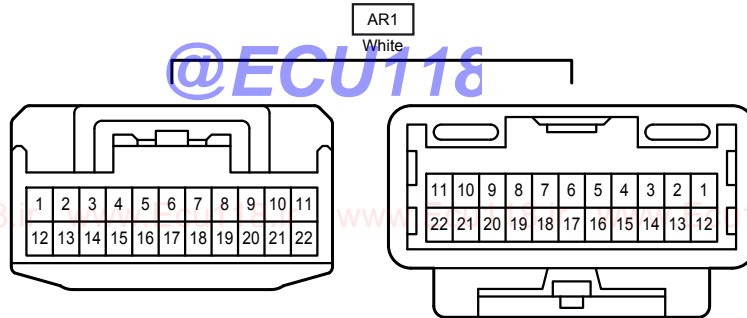
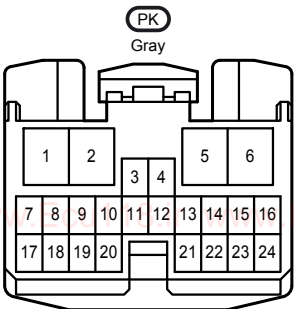
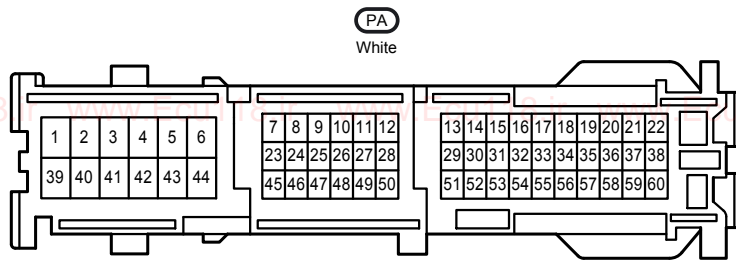
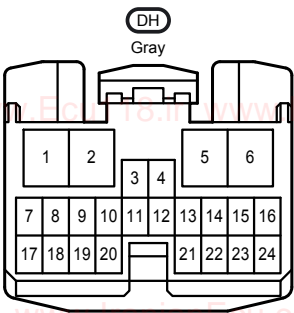
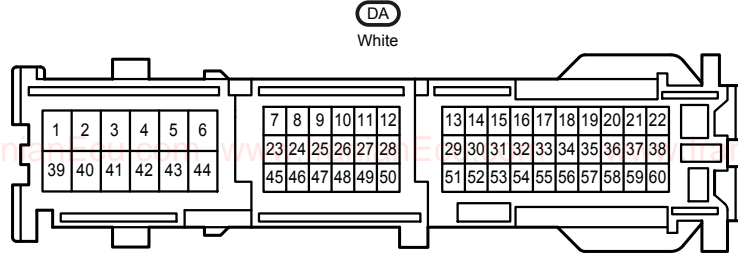
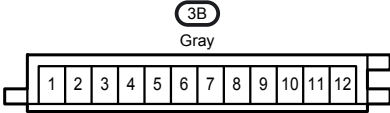
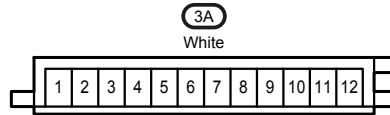
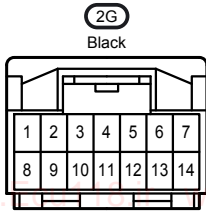
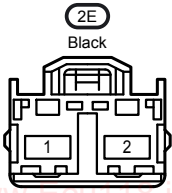

AS2
White

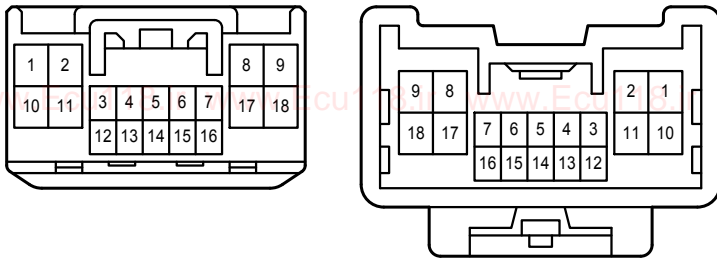

AS5
White

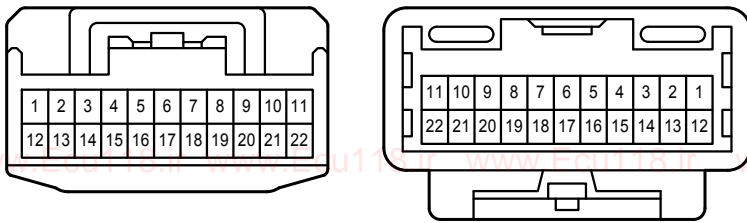

EA1
White

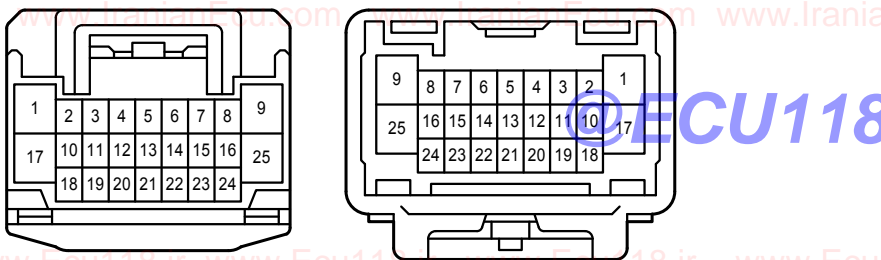

EA2
White

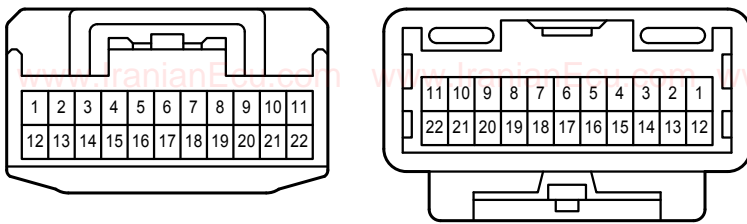

EA3
White

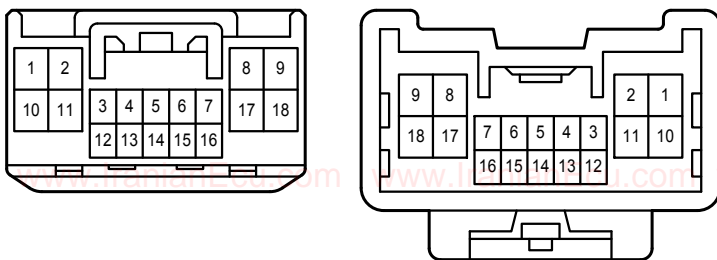

EA4
White

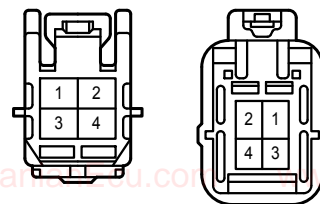

Engine Control

EH1
Gray

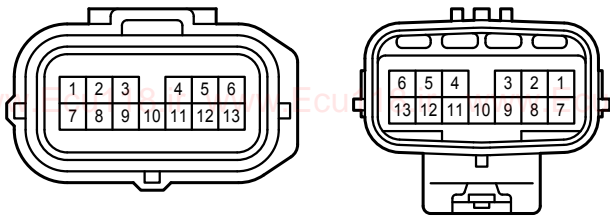

Ez1
Gray

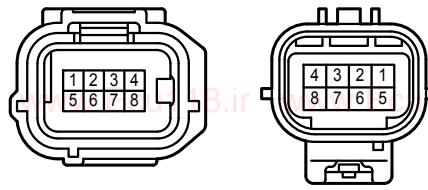

Ez2
Gray

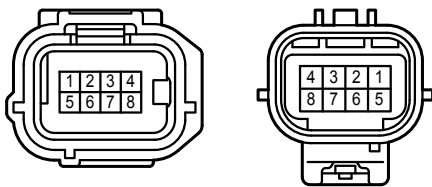

LA1
White

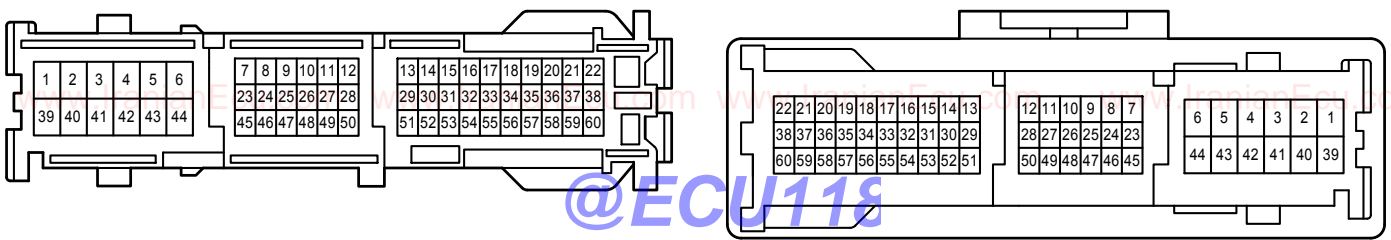

VS1
Black

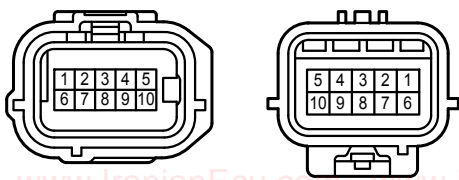

mS1
White

